

令和6年度 板橋区職員定数増減概要

(議案第15号関係資料)

企画総務委員会
令和6年2月15日
総務部人事課

	5年度	新規事業	既定事業		差引	6年度
			増	減		
政策経営部	132	<ul style="list-style-type: none"> 学校改築・長寿命化工事等の推進 (教育施設担当課長) [実計][経革][組織] 	<ul style="list-style-type: none"> 1・DX推進に必要な人材育成 (IT推進課)[経革] 4・区民・教育施設の整備促進 (施設経営課)[実計][経革] 	<ul style="list-style-type: none"> 1 	6	138
総務部	343		<ul style="list-style-type: none"> 1・統計調査実施による業務増 (総務課) [7年度までの時限] 	<ul style="list-style-type: none"> 1・業務の効率化 (契約管財課) 	△1	343
危機管理部	28	<ul style="list-style-type: none"> 1・防災予防・応急・復旧対策の充実 (防災危機管理課) [6年度限りの時限] 	<ul style="list-style-type: none"> 1・地区別防災対策マニュアル作成 (改定)支援 (地域防災支援課) [8年度までの時限] 	<ul style="list-style-type: none"> 1・板橋区地域防災計画等の改定 (防災危機管理課) [時限終了] △2・個別避難計画作成の業務移管 (地域防災支援課) 	△1	△1 27
区民文化部	245		<ul style="list-style-type: none"> 1・振り仮名記載に伴う業務増 (戸籍住民課) [7年度までの時限] 1・戸籍の広域交付開始に伴う業務増 (戸籍住民課) 6・再任用短時間ポストの見直し (5地域センター、文化・国際交流課) 	<ul style="list-style-type: none"> 1・電子書籍AI検索サービス導入による 業務のスマート化 (戸籍住民課) 	△2	6 251
産業経済部	57	<ul style="list-style-type: none"> 1・産業ミュージアムの整備促進 (産業振興課)[実計][組織] 			1	58
健康 生きがい部 保健所	466	<ul style="list-style-type: none"> 6・健康危機管理体制の強化 (健康推進課)[組織] 3・精神保健事業の一体的実施 (健康推進課)[組織] 1・予防対策課庶務機能の移管 (予防対策課)[組織] 	<ul style="list-style-type: none"> 1・高齢者の個別避難計画作成 (長寿社会推進課) 1・母子保健・子育て支援事業の拡充 (健康推進課) 1・再任用短時間ポストの見直し (おとしより保健福祉センター) 1・高齢者の保健事業と介護予防の 一体的実施の拡充 (おとしより保健福祉センター) 	<ul style="list-style-type: none"> 1・健康づくり事業の統廃合 (健康推進課)[組織] 1・予防接種係の統合 (予防対策課)[組織] 1・精神保健施策等の統廃合 (予防対策課)[組織] 1・感染症対策事業の見直し (感染症対策課)[組織] 	△3 △1 △8 △7	△5 461
福祉部	378	<ul style="list-style-type: none"> 8・障がい児支援の充実 (障がいサービス課)[組織] 	<ul style="list-style-type: none"> 3・臨時給付金交付体制の構築 (生活支援課) 1・行旅死亡人等の増加対応 再任用短時間ポストの見直し (生活支援課) 1・障がい者の個別避難計画作成 (障がいサービス課) -「ひとつの福祉事務所」への転換 (板橋・赤塚・志村福祉課) [組織] 	<ul style="list-style-type: none"> 3・障がい支援業務の見直し (障がい政策課、障がいサービス課、 板橋・赤塚・志村福祉事務所)[組織] 	△8	5 383

	5年度	新規事業	既定事業		差引	6年度	
			増	減			
子ども家庭部	1,014	子ども家庭総合支援センターの組織・運営体制の確立検討(子ども専門相談担当課長)[組織]	1	1	△ 11	△ 4	1,010
資源環境部	243			1	△ 1		243
都市整備部	99			1	△ 1	1	100
まちづくり推進室	42			1		4	46
土木部	173		2	1		3	176
会計管理室	19						19
教育委員会事務局	205		1		△ 1	△ 2	203
学校園	116				△ 4	△ 4	112
選挙管理委員会事務局	11						11
監査委員事務局	11						11
区議会事務局	18						18
合計	3,600		25	46	△ 61	10	3,610

総務部の定数には、保留定数を含む。

○職員定数増減(令和6年4月1日現在)

※各部(課)の庶務担当係には、部長、課長を含む。

<p>改正前</p> <div style="display: flex; justify-content: space-around; align-items: center;"> <div style="border: 1px dashed black; padding: 2px;">廃止</div> <div style="border: 1px dashed black; padding: 2px;">変更</div> <div style="border: 1px solid black; padding: 2px;">所管替</div> </div> <p>※任用上の係長を除く</p>	<p>改正後</p> <div style="display: flex; justify-content: space-around; align-items: center;"> <div style="border: 1px solid black; padding: 2px;">新設</div> <div style="border: 1px dashed black; padding: 2px;">変更</div> <div style="border: 1px solid black; padding: 2px;">所管替</div> </div> <p>※任用上の係長を除く</p>
---	--

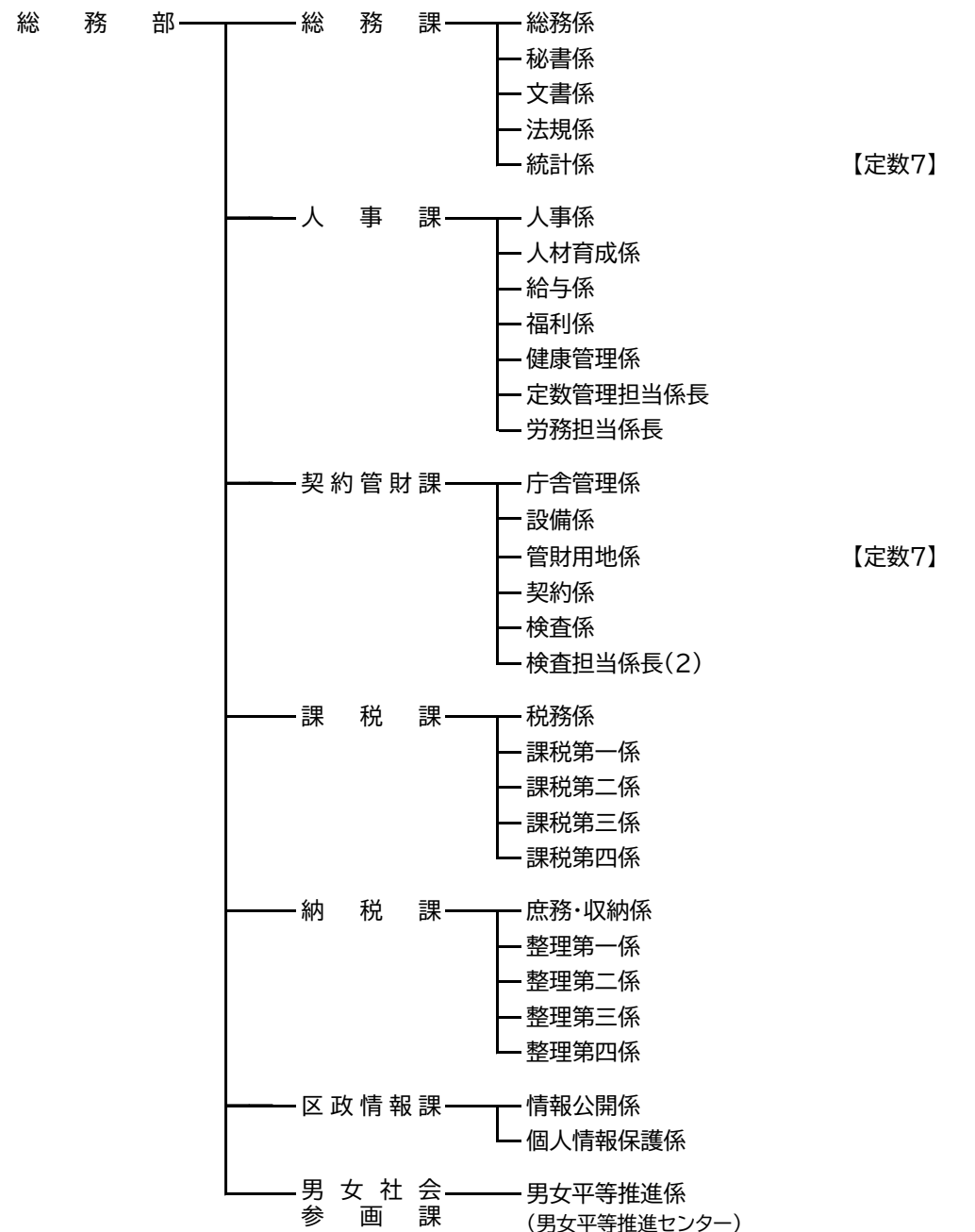
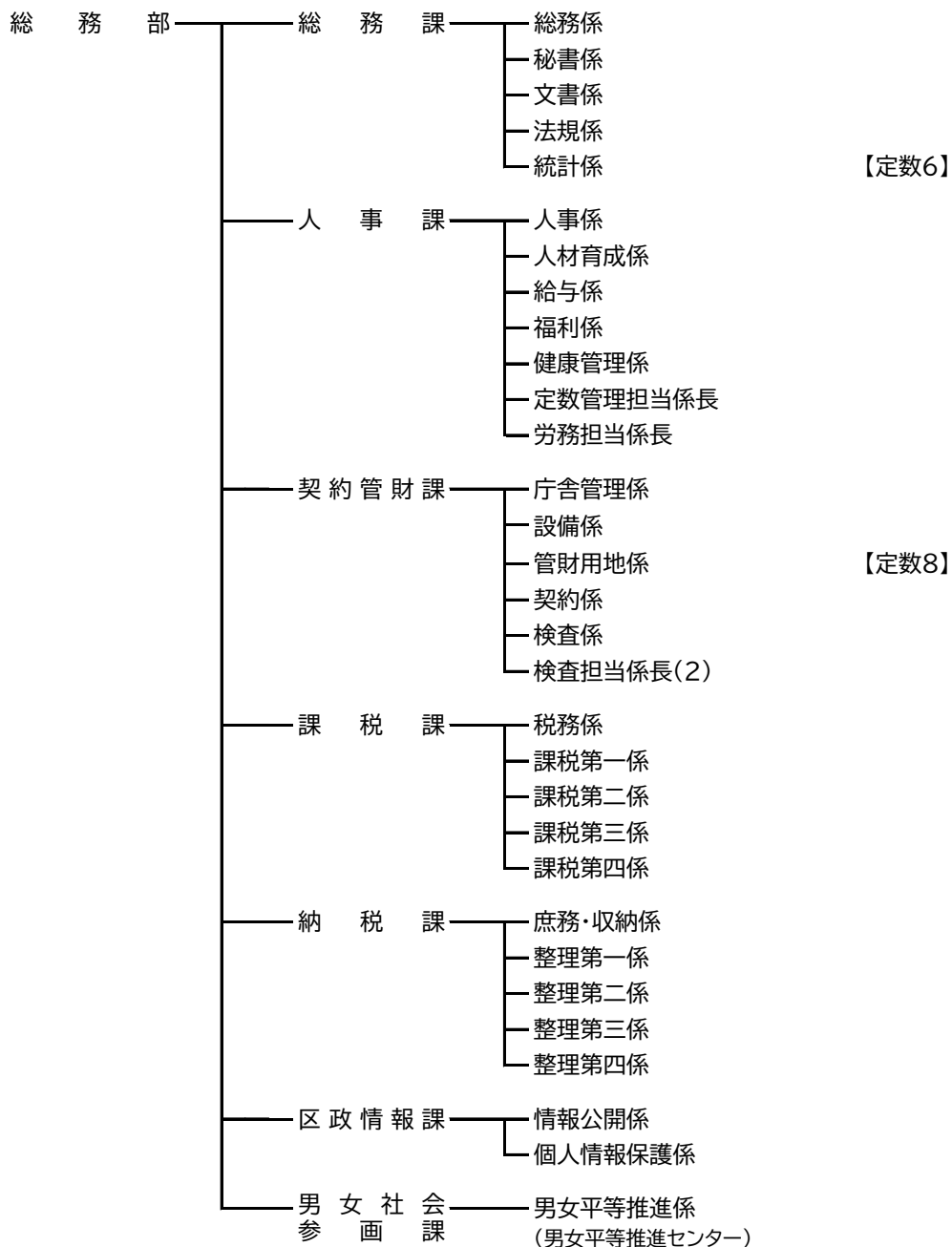
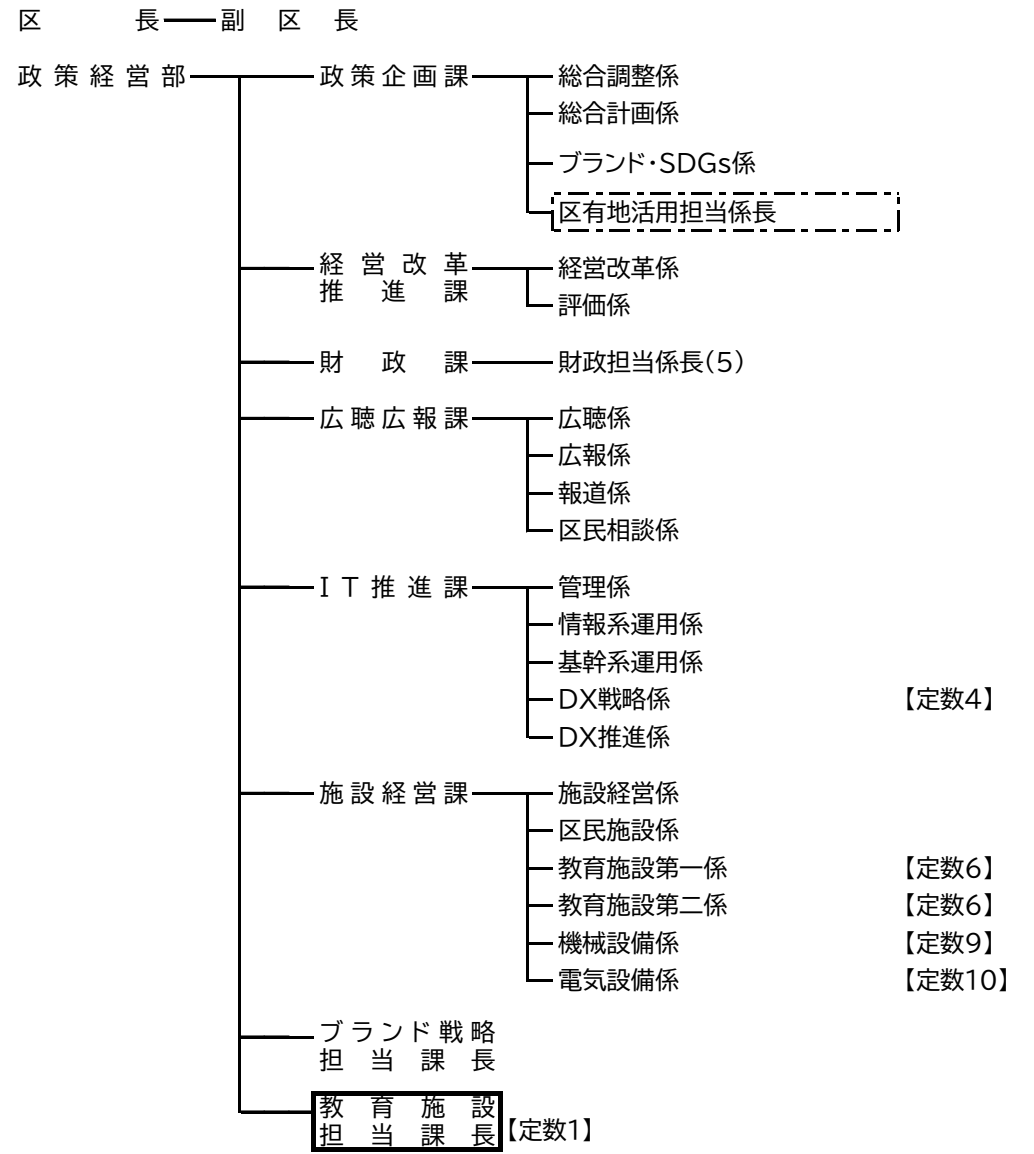
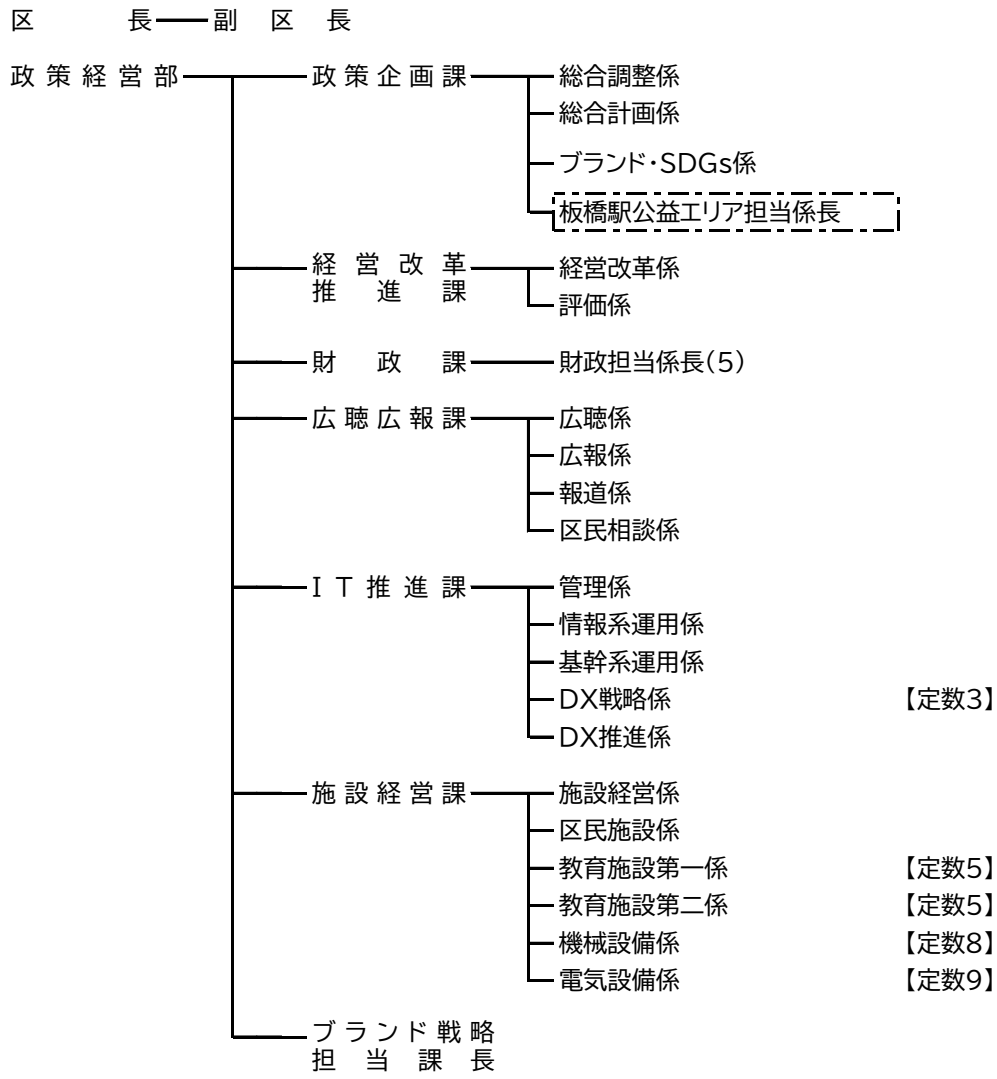

法務専門監

法務専門監

○職員定数増減(令和6年4月1日現在)

※各部(課)の庶務担当係には、部長、課長を含む。

<p>改正前</p> <div style="display: flex; justify-content: space-around; align-items: center;"> <div style="border: 1px dashed black; padding: 2px;">廃止</div> <div style="border: 1px dashed black; padding: 2px;">変更</div> <div style="border: 2px solid black; padding: 2px;">所管替</div> </div> <p>※任用上の係長を除く</p>	<p>改正後</p> <div style="display: flex; justify-content: space-around; align-items: center;"> <div style="border: 2px solid black; padding: 2px;">新設</div> <div style="border: 1px dashed black; padding: 2px;">変更</div> <div style="border: 2px solid black; padding: 2px;">所管替</div> </div> <p>※任用上の係長を除く</p>
---	--

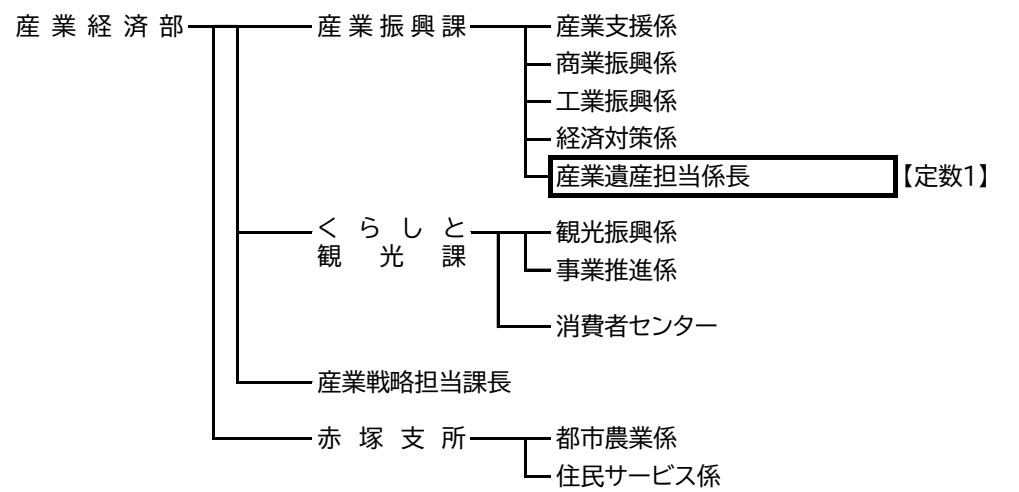
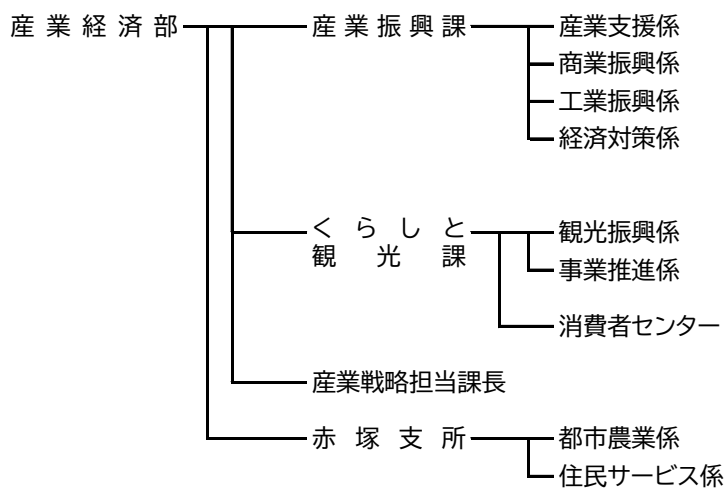
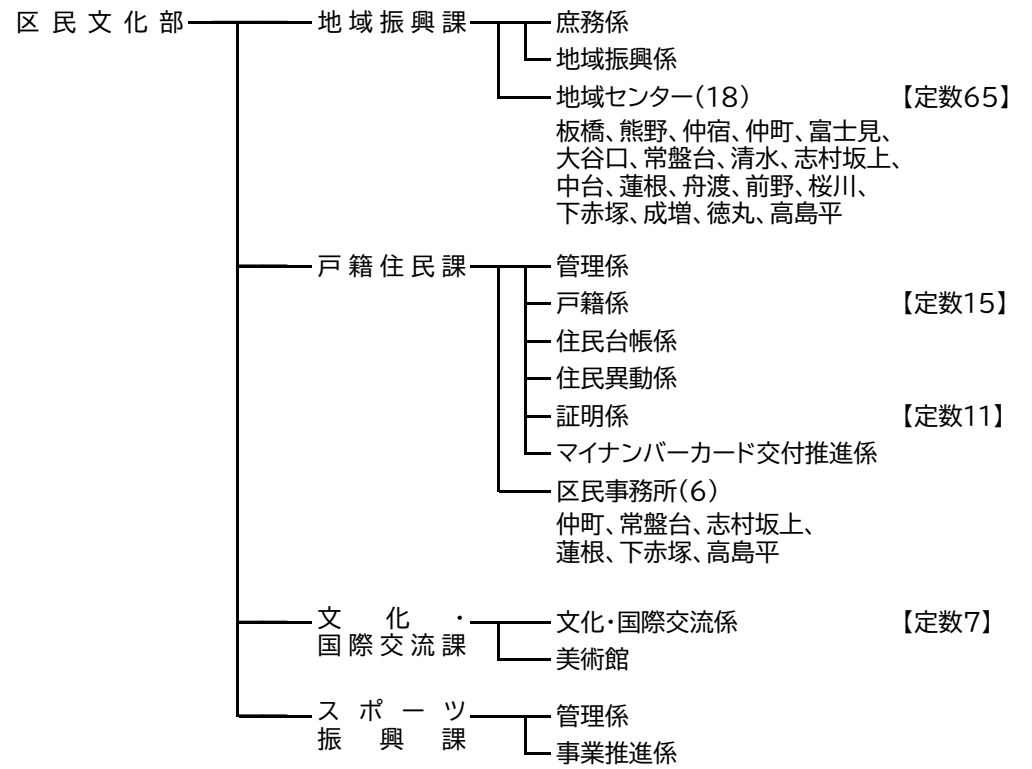
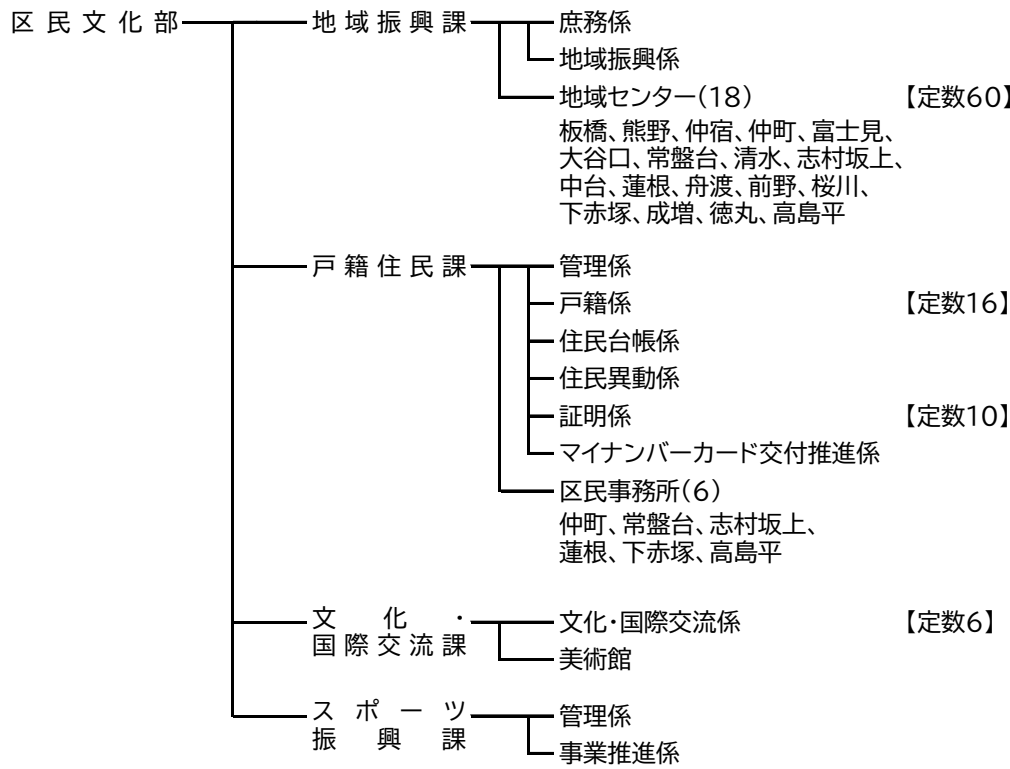
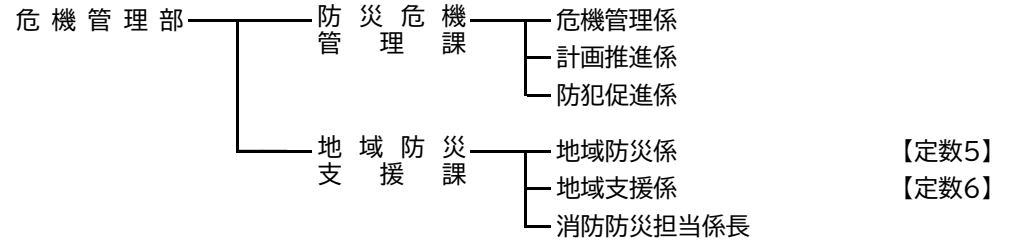
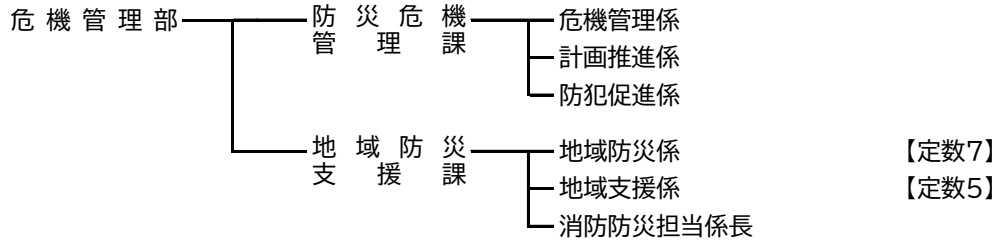

○職員定数増減(令和6年4月1日現在)

※各部(課)の庶務担当係には、部長、課長を含む。

<p>改正前</p> <div style="display: flex; justify-content: space-around; align-items: center;"> <div style="border: 1px dashed black; padding: 2px;">廃止</div> <div style="border: 1px dashed black; padding: 2px;">変更</div> <div style="border: 1px solid black; padding: 2px;">所管替</div> </div> <p>※任用上の係長を除く</p>	<p>改正後</p> <div style="display: flex; justify-content: space-around; align-items: center;"> <div style="border: 1px solid black; padding: 2px;">新設</div> <div style="border: 1px dashed black; padding: 2px;">変更</div> <div style="border: 1px solid black; padding: 2px;">所管替</div> </div> <p>※任用上の係長を除く</p>
---	--

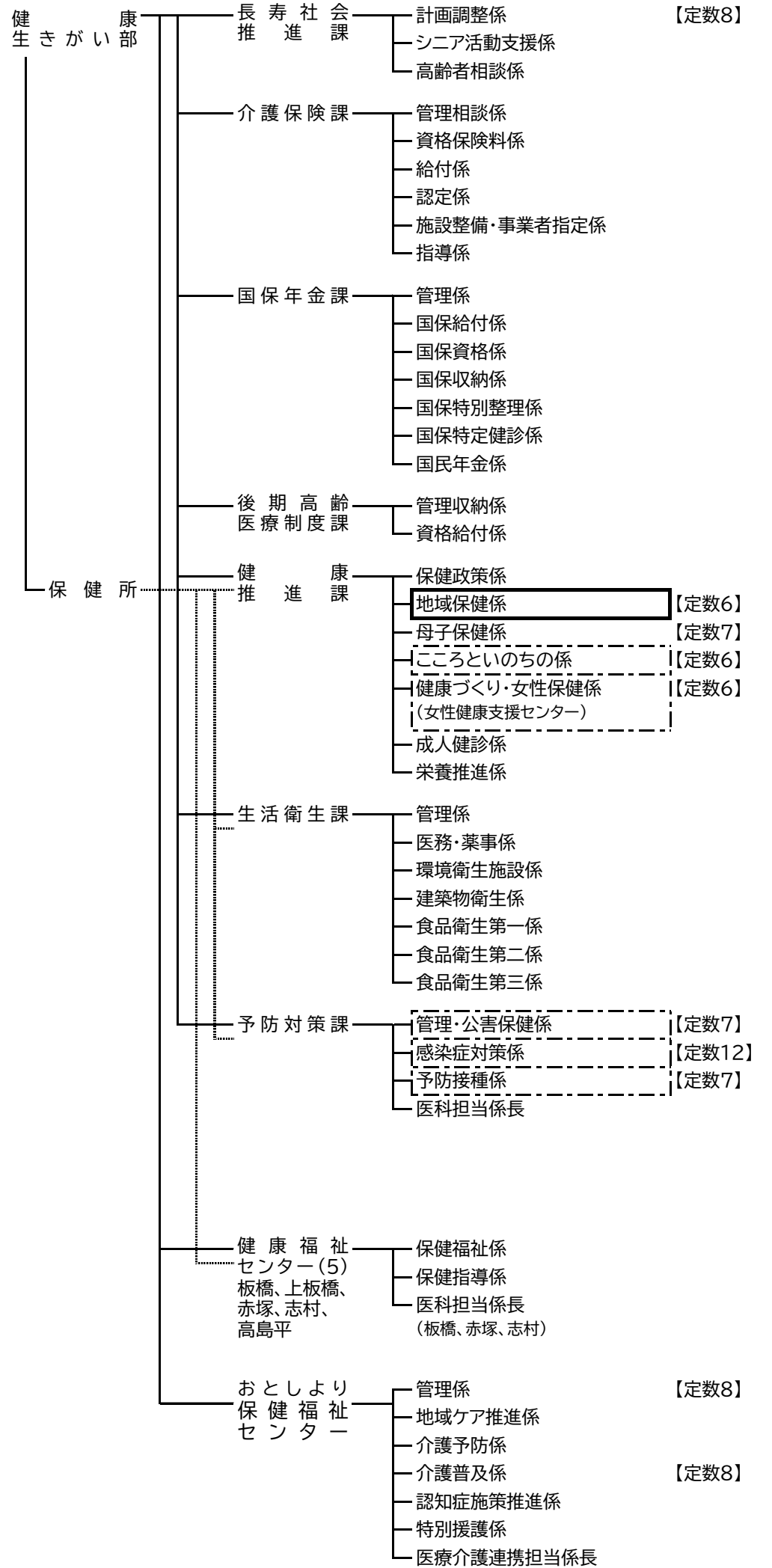
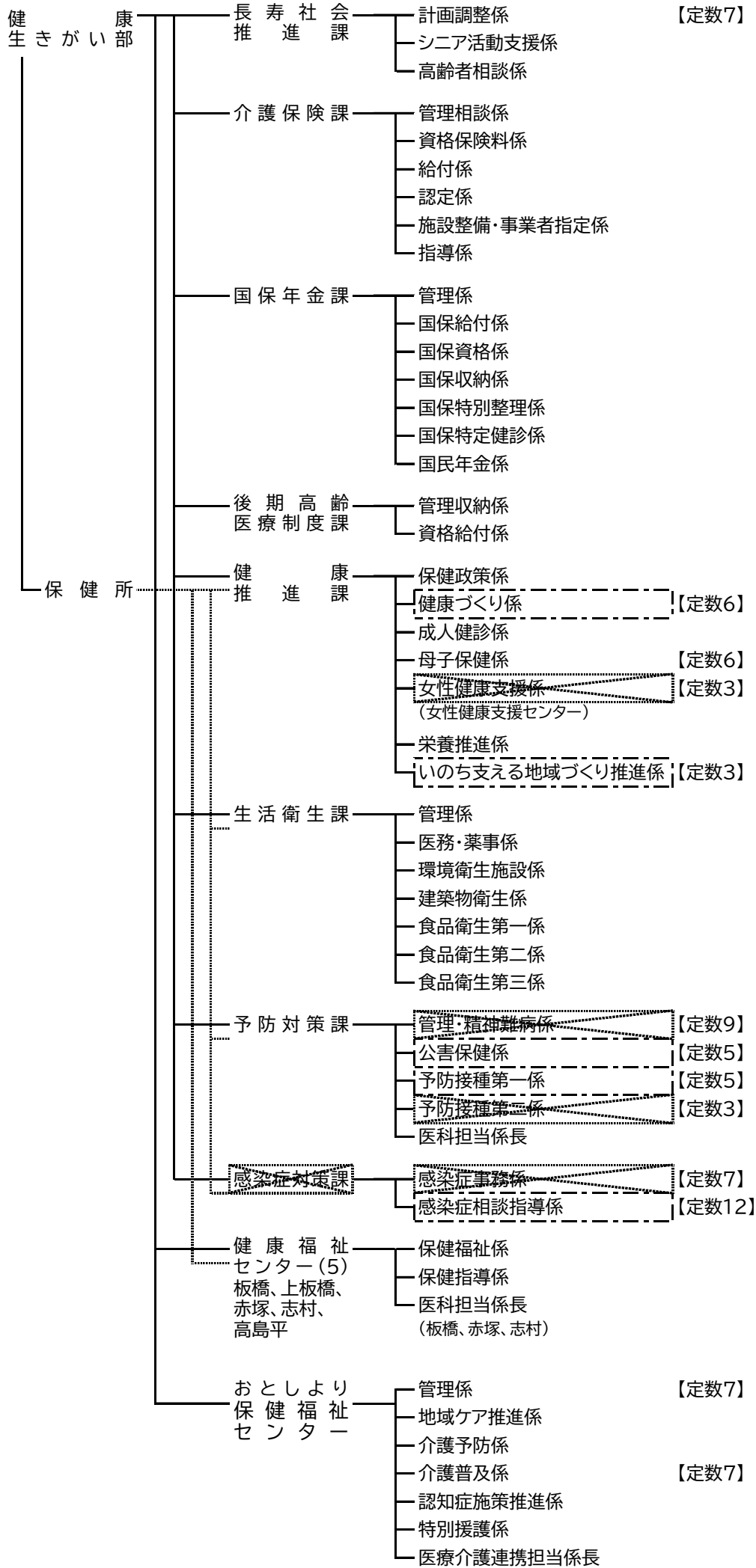

○職員定数増減(令和6年4月1日現在)

※各部(課)の庶務担当係には、部長、課長を含む。

<p>改正前</p> <div style="display: flex; justify-content: space-around; align-items: center;"> <div style="border: 1px dashed black; padding: 2px;">廃止</div> <div style="border: 1px dashed black; padding: 2px;">変更</div> <div style="border: 1px solid black; padding: 2px;">所管替</div> </div> <p>※任用上の係長を除く</p>	<p>改正後</p> <div style="display: flex; justify-content: space-around; align-items: center;"> <div style="border: 1px solid black; padding: 2px;">新設</div> <div style="border: 1px dashed black; padding: 2px;">変更</div> <div style="border: 1px solid black; padding: 2px;">所管替</div> </div> <p>※任用上の係長を除く</p>
---	--

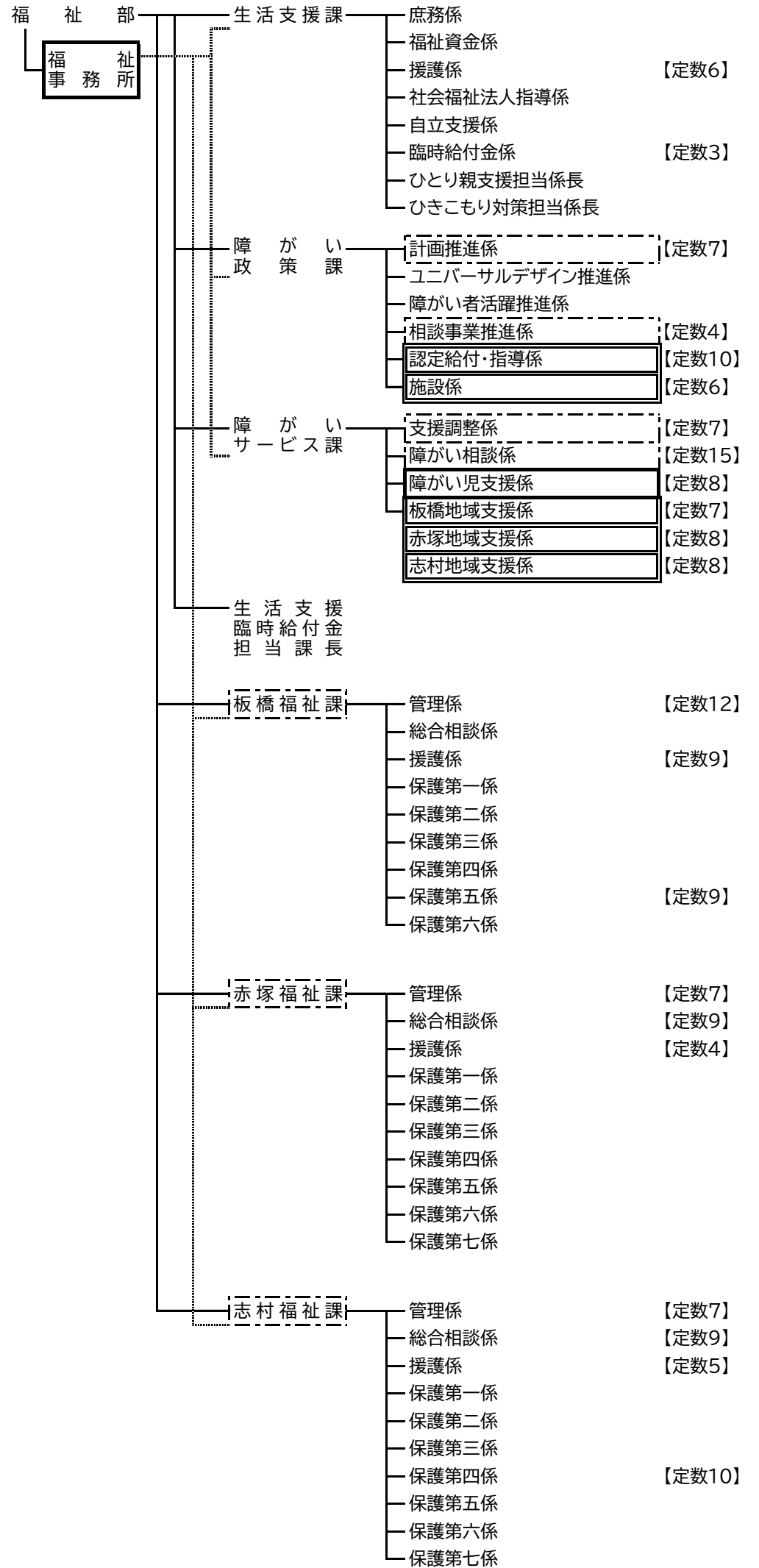
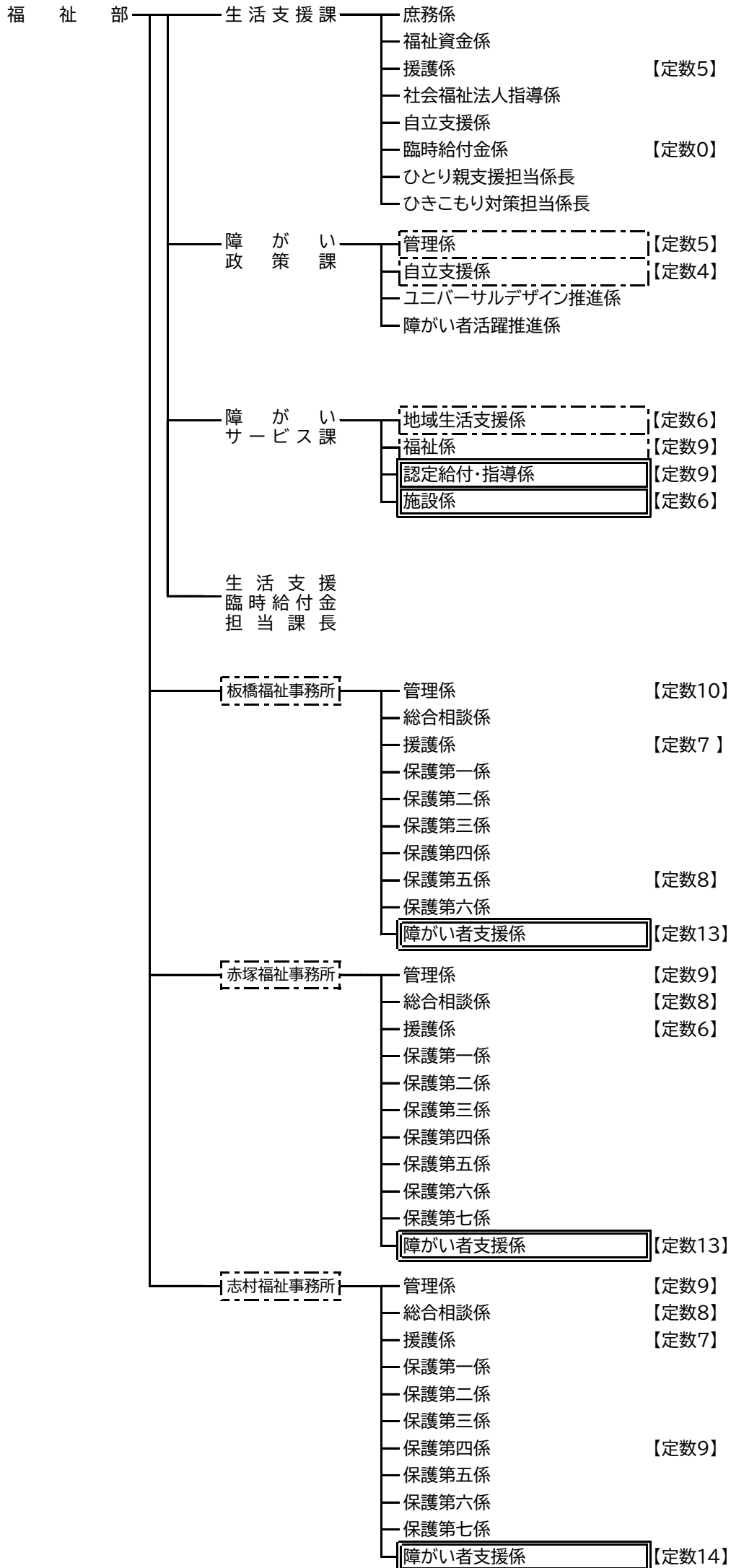

○職員定数増減(令和6年4月1日現在)

※各部(課)の庶務担当係には、部長、課長を含む。

<p>改正前</p> <div style="display: flex; justify-content: space-around; align-items: center;"> <div style="border: 1px dashed black; padding: 2px;">廃止</div> <div style="border: 1px dashed black; padding: 2px;">変更</div> <div style="border: 2px solid black; padding: 2px;">所管替</div> </div> <p>※任用上の係長を除く</p>	<p>改正後</p> <div style="display: flex; justify-content: space-around; align-items: center;"> <div style="border: 2px solid black; padding: 2px;">新設</div> <div style="border: 1px dashed black; padding: 2px;">変更</div> <div style="border: 2px solid black; padding: 2px;">所管替</div> </div> <p>※任用上の係長を除く</p>
--	---

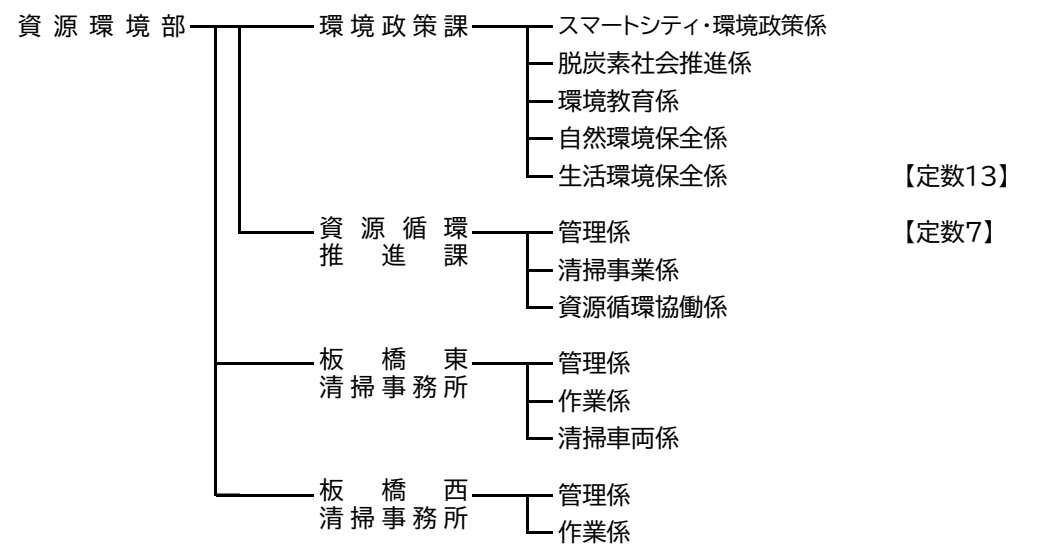
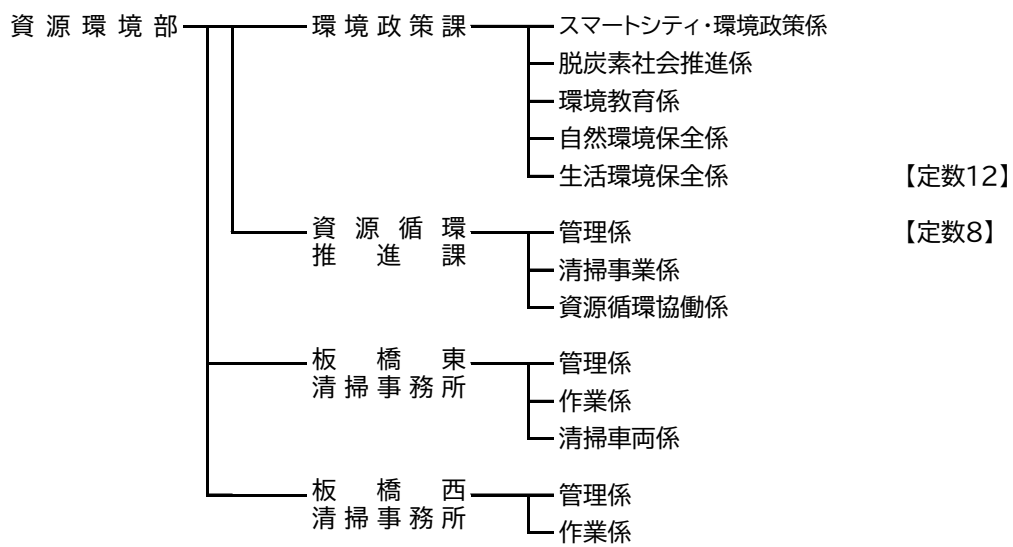
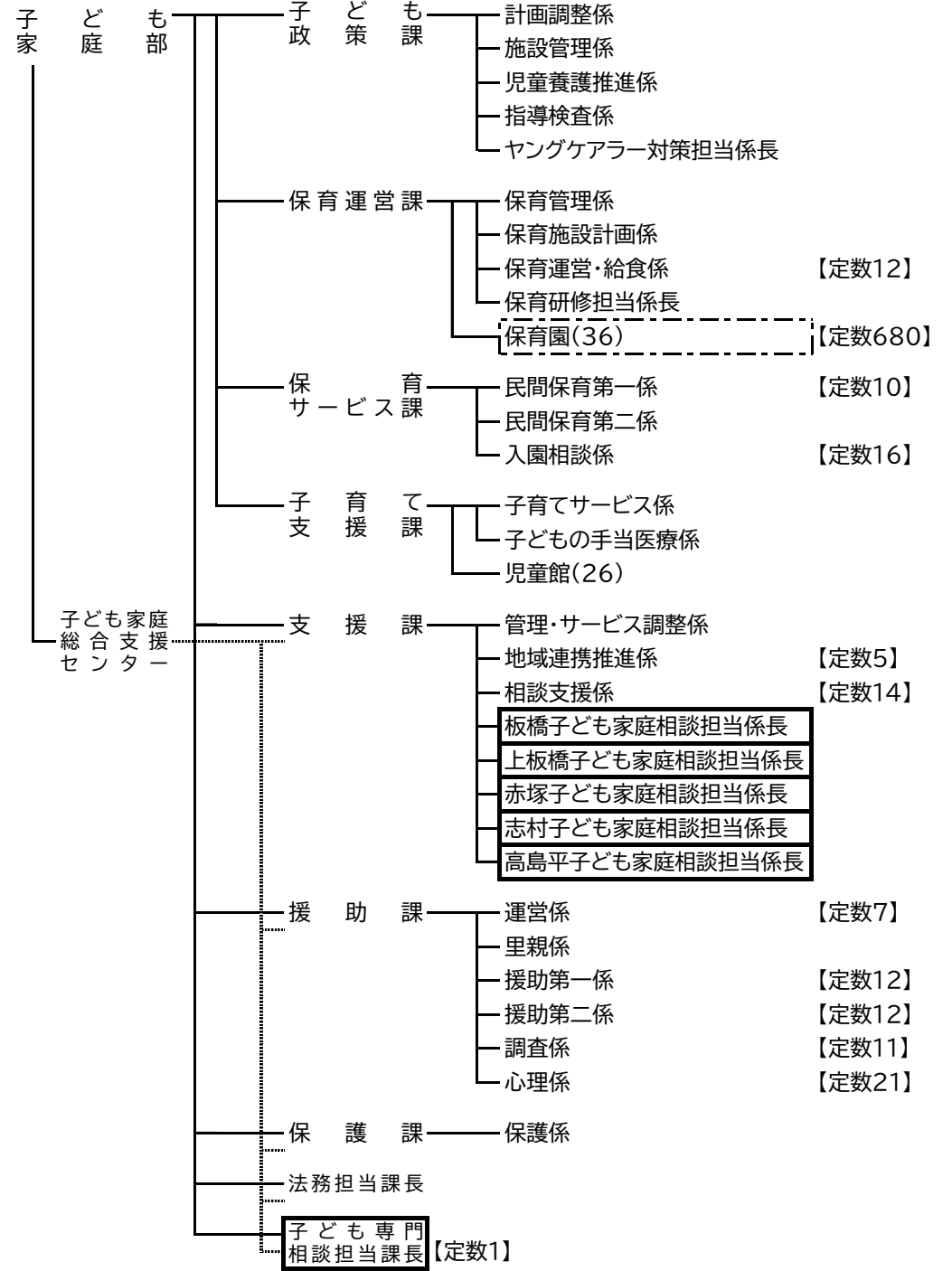
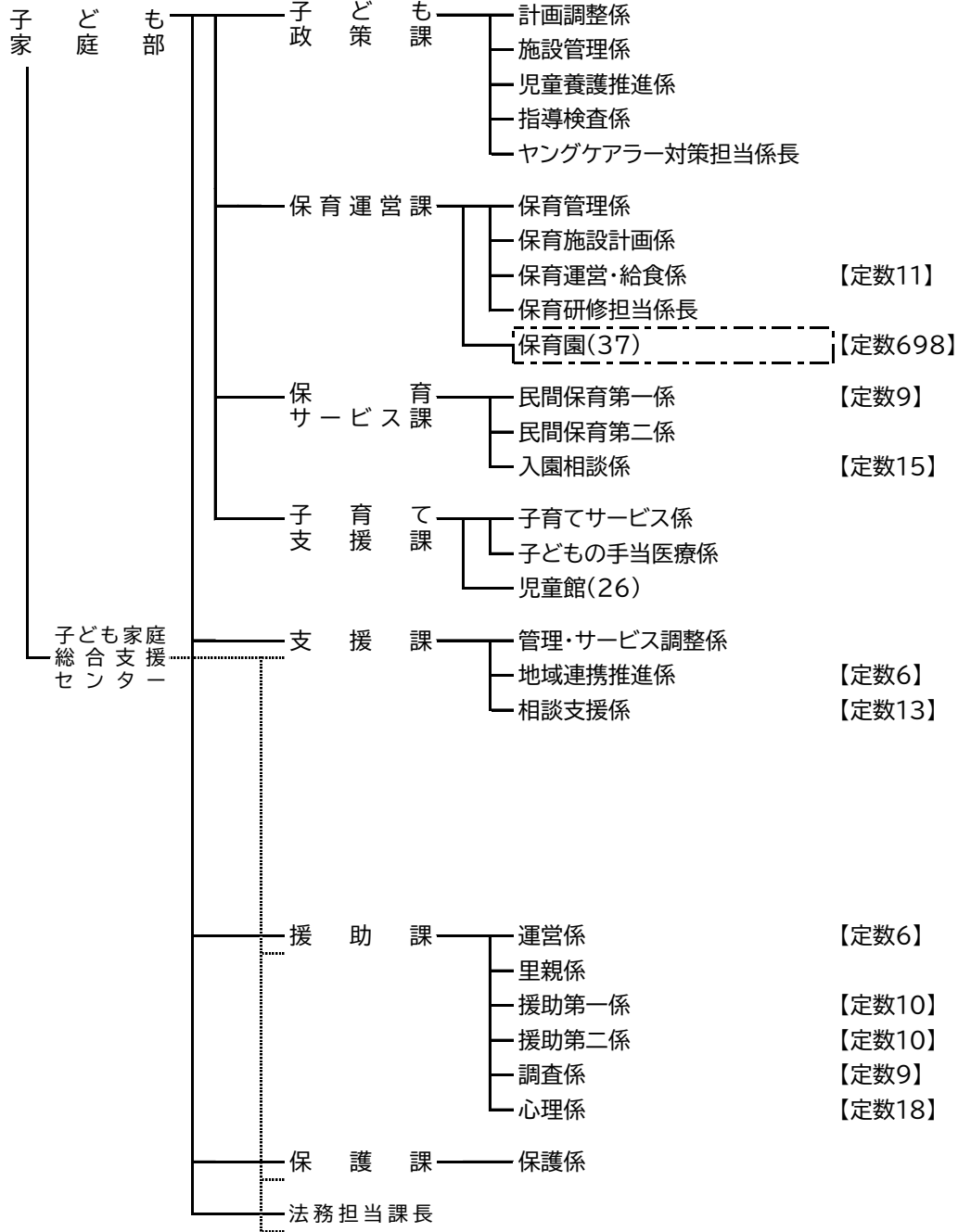

○職員定数増減(令和6年4月1日現在)

※各部(課)の庶務担当係には、部長、課長を含む。

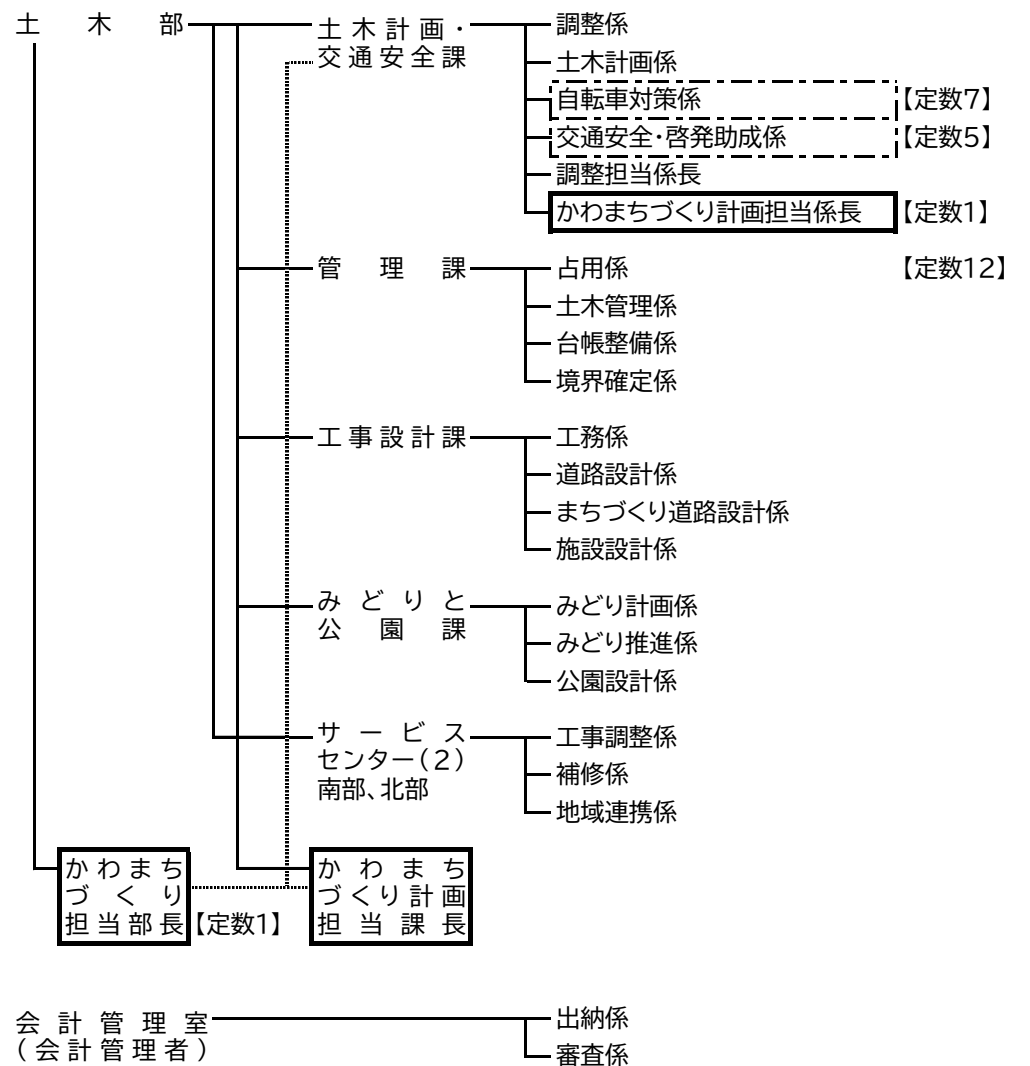
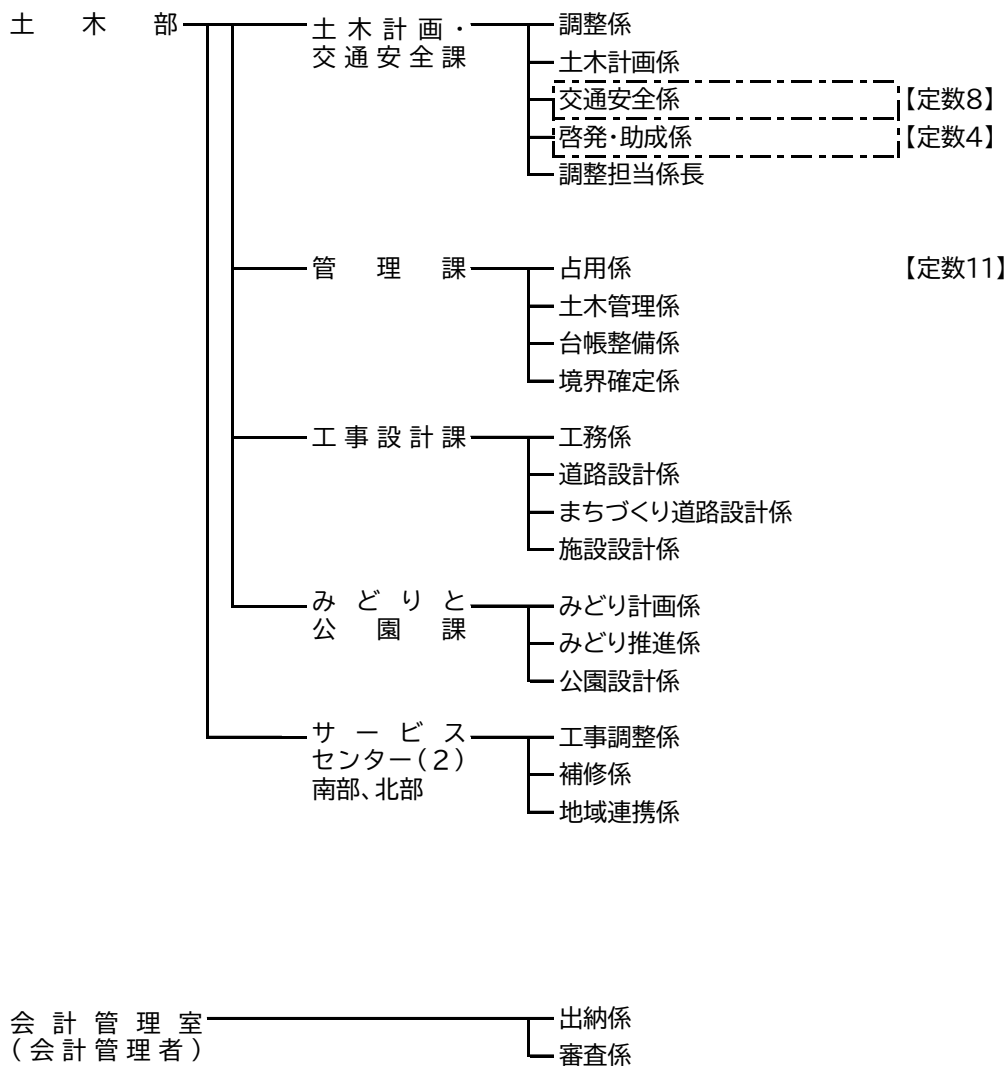
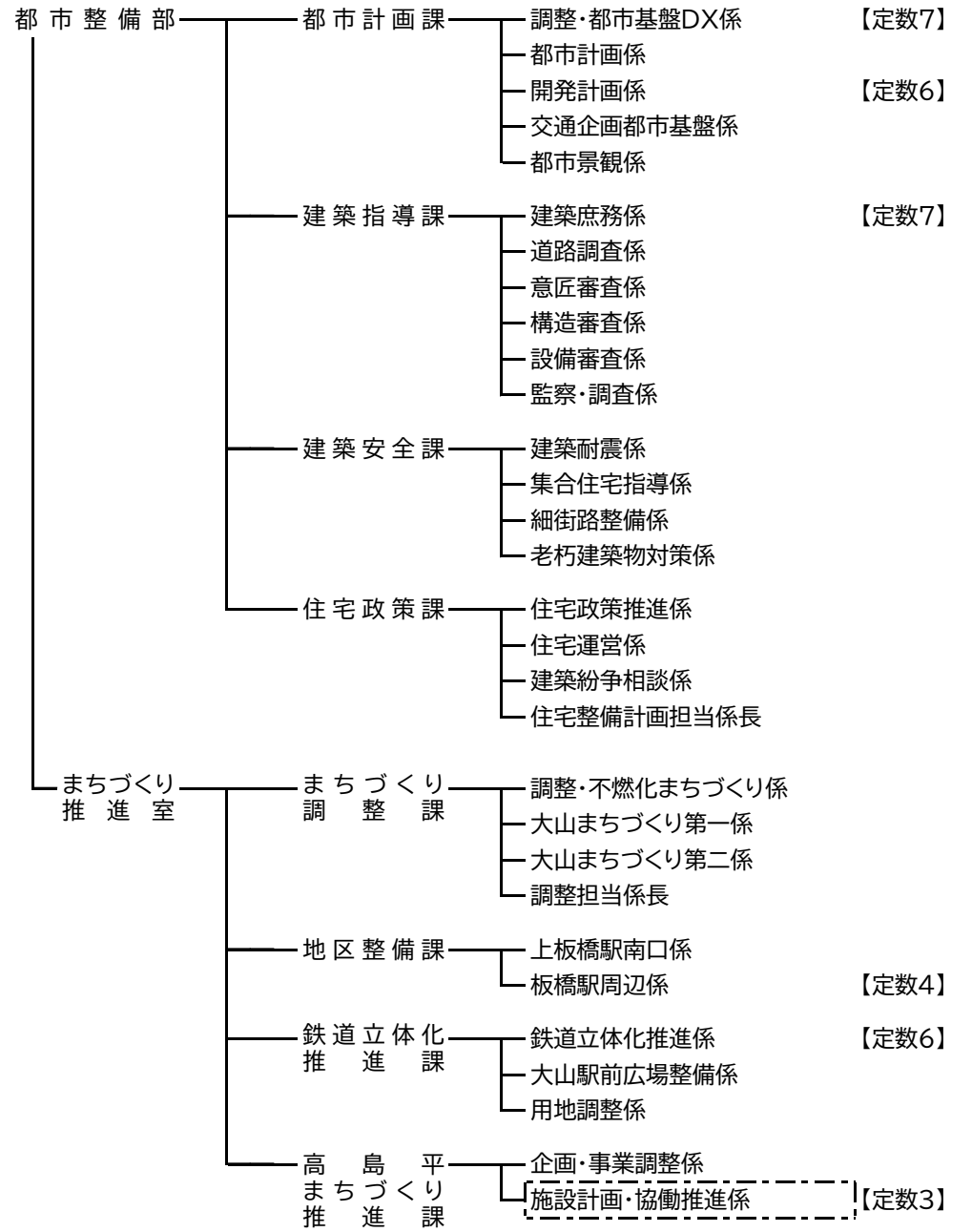
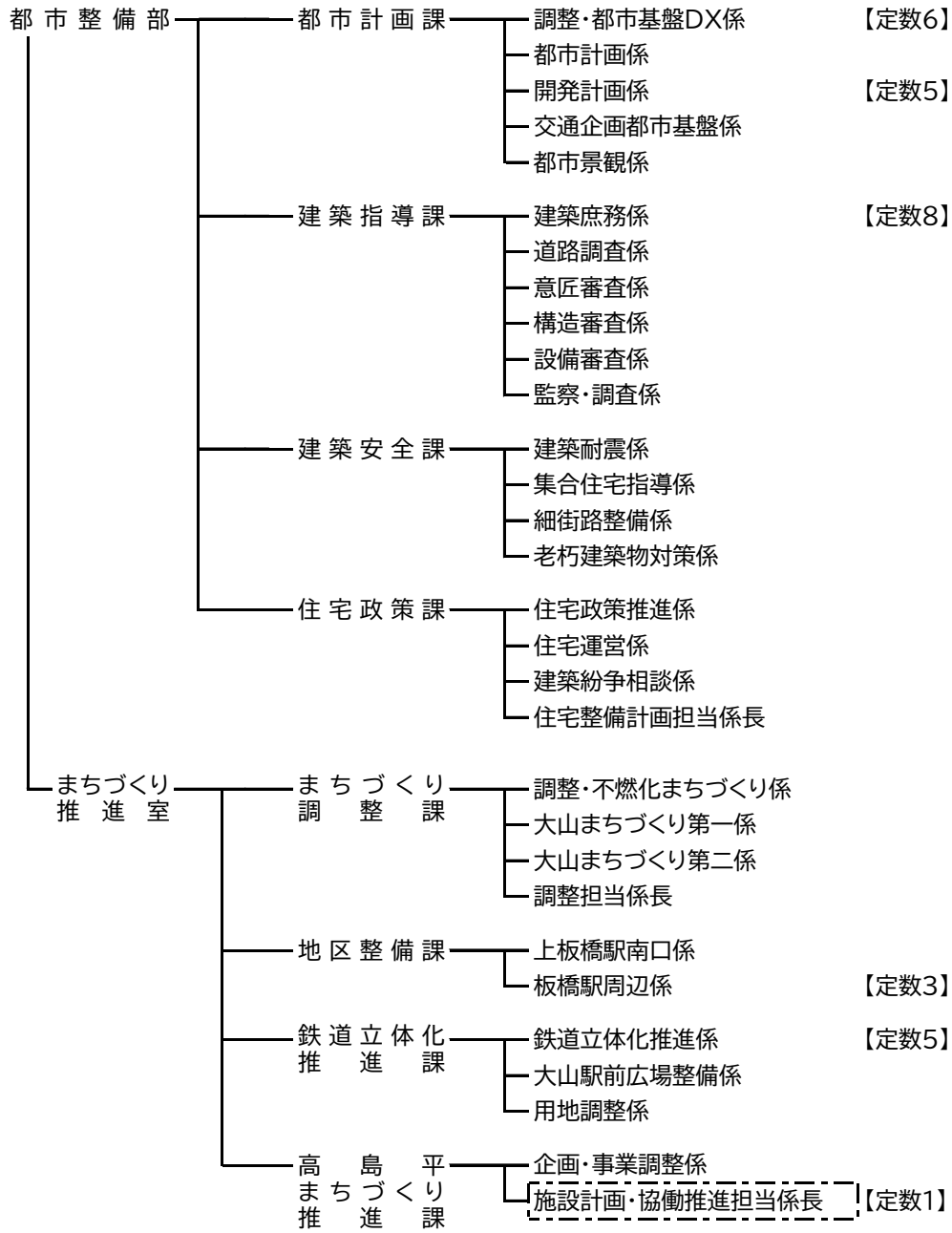

○職員定数増減(令和6年4月1日現在)

※各部(課)の庶務担当係には、部長、課長を含む。

<p>改正前</p> <div style="display: flex; justify-content: space-around; align-items: center;"> <div style="border: 1px dashed black; padding: 2px;">廃止</div> <div style="border: 1px dashed black; padding: 2px;">変更</div> <div style="border: 1px solid black; padding: 2px;">所管替</div> </div> <p>※任用上の係長を除く</p>	<p>改正後</p> <div style="display: flex; justify-content: space-around; align-items: center;"> <div style="border: 1px solid black; padding: 2px;">新設</div> <div style="border: 1px dashed black; padding: 2px;">変更</div> <div style="border: 1px solid black; padding: 2px;">所管替</div> </div> <p>※任用上の係長を除く</p>
---	--

